S T E I N W A Y L Y N G D O R F

IW-66

INSTALLATION MANUAL

November 2, 2016

S T E I N W A Y L Y N G D O R F

Introduction.....	3
Compliance.....	3
Unpacking.....	4
Inventory.....	4
Installation	5
Preparing the wall for the speaker.....	5
Removing the brackets from each speaker unit	5
Mounting the brackets.....	6
Connecting the loudspeaker cables	8
Mounting the top and bottom brackets	9
Mounting the speaker in the wall.....	10
Service Information.....	12

Introduction

Please read all material carefully prior to installation. If you need additional assistance, contact your Steinway Lyngdorf representative or email service@steinwaylyngdorf.com.

Compliance

WEEE

The European Parliament and the Council of the European Union have issued the Waste Electrical and Electronic Equipment Directive. The purpose of the Directive is to prevent waste of electrical and electronic equipment and to promote reuse, recycling, and other forms of waste recovery. Steinway Lyngdorf products and the accessories packed with them are subject to the WEEE Directive. Please dispose of any waste materials in accordance with your local recycling regulations. Products and equipment which must be collected for reuse, recycling, and other forms of recovery are marked with the icon of the crossed-out waste receptacle.



FCC

Steinway Lyngdorf products and accessories comply with parts 15 and 68 of the FCC rules. Operation is subject to the following two conditions: (1) this device may not cause harmful interference; and (2) this device must accept any interference received, including any interference that may cause undesired operation. Changes or modifications not expressly approved by the party responsible for compliance could void the user's authority to operate the equipment. Equipment marketed to a consumer must be capable of complying with the necessary regulations in the configuration in which the equipment is marketed.



S T E I N W A Y L Y N G D O R F

Unpacking

Carefully remove the speaker and accessories from the carton, and check for shipping damage. Contact both the shipper and your Steinway Lyngdorf representative immediately if products bear any sign of damage or if there is a discrepancy in the number of packages received. All Steinway Lyngdorf equipment is carefully inspected before leaving our factory. Note: Keep the shipping carton and all packing material for future use or in the unlikely event that products require servicing. If products are shipped without the original packing, damage could occur and void the warranty.

Inventory

Check to ensure that all necessary product components have been delivered. Report all discrepancies to your Steinway Lyngdorf representative immediately.

- Brackets for securing the individual loudspeaker units to each other are attached to the units prior to shipping.
- Adjustable brackets for securing the speaker to the wall.
- Spikes.

Installation

Preparing the wall for the speaker

For proper mounting of the IW-66 loudspeaker, a rectangular cutout with the following dimensions must be made in the wall:

- Height at least 150 cm (59.1 in).
- Width at least 36 cm (14.17 in) and no more than 37.0 cm (14.57 in)
- Depth at least 20 cm (7.87 in)

Note: If not recessed into the wall, the IW-66 speaker top bracket will protrude 3mm (0.12 in).

Removing the brackets from each speaker unit

All loudspeaker units are equipped with metal brackets from the factory. Using a TORX 30 type screwdriver, remove the screws securing the brackets to the loudspeakers.

Note: The top and bottom cabinets are assembled as one unit for shipping.

- Remove the side braces holding the top and bottom cabinets together.
- Remove the side braces on the center unit.

Mounting the brackets

Place the center unit between the top and bottom cabinets and reattach the four (4) braces along both sides of the speaker.

Note the orientation of upper and lower units when assembling the speaker. Cabinets should be aligned so drivers on the top and bottom cabinet are close to center cabinet drivers when attached.

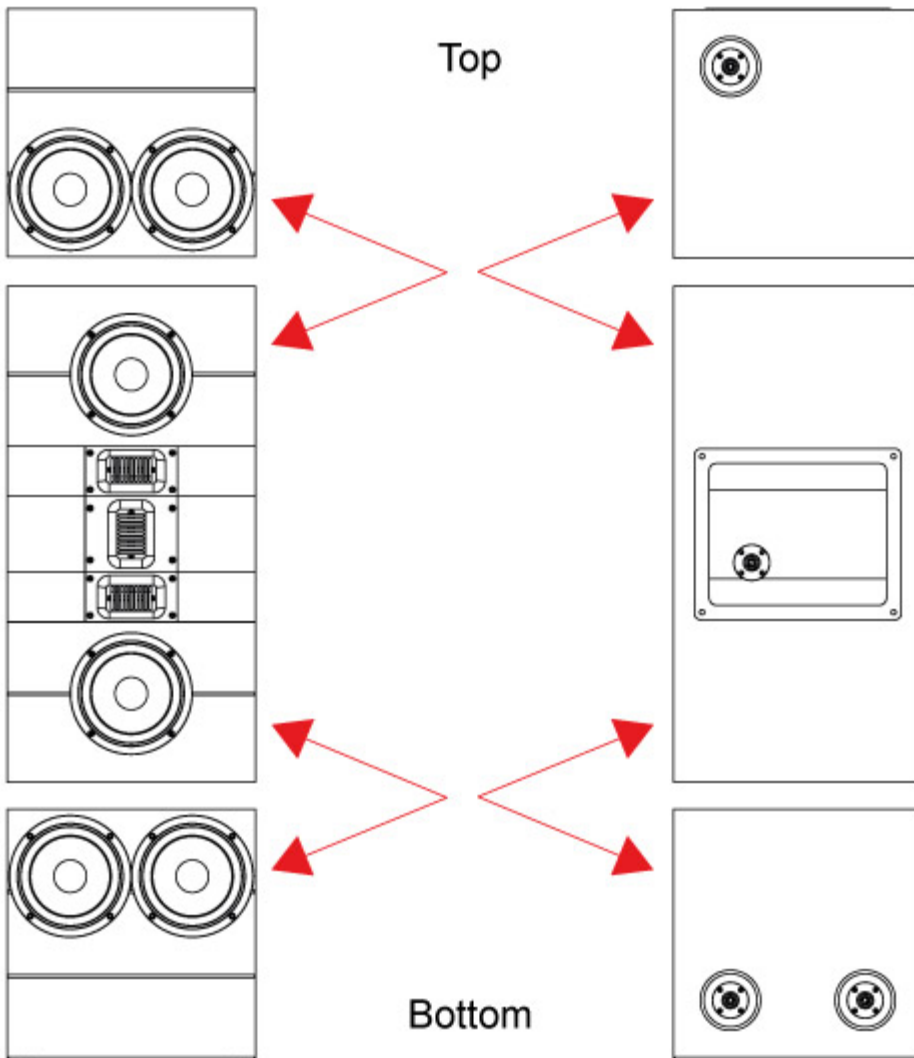

S T E I N W A Y L Y N G D O R F

Secure the side brackets to the loudspeaker units as shown. The bracket must bridge two loudspeakers in such a way that the bracket can be affixed to each loudspeaker with two screws.

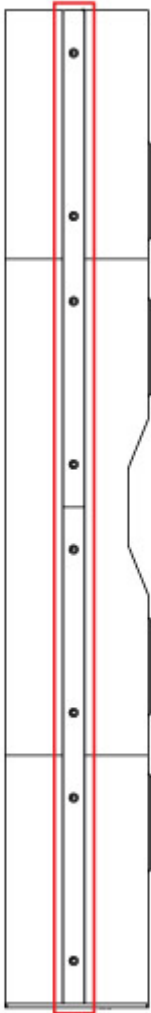

1. Insert the screws into all four holes and tighten them by hand until the head of each screw protrudes 2 mm / 1/16 in.
2. Tighten the screws with a TORX 30 screwdriver.

Note: Do not mount the bracket and then insert and tighten one screw at a time, as this presents a risk that the last screw will not be fully aligned with the hole. Tightening the last screw can then result in the screw thread being stripped, rendering the screw useless.

Connecting the loudspeaker cables

The IW-66 speaker needs two channels of amplification: one for the top and bottom speakers, which are daisy-chained, and one for the middle speaker.

1. Connect the first cable to the bottom socket on the bottom loudspeaker.
2. Daisy-chain the bottom loudspeaker to the top loudspeaker.
3. Connect the middle speaker via the second cable.

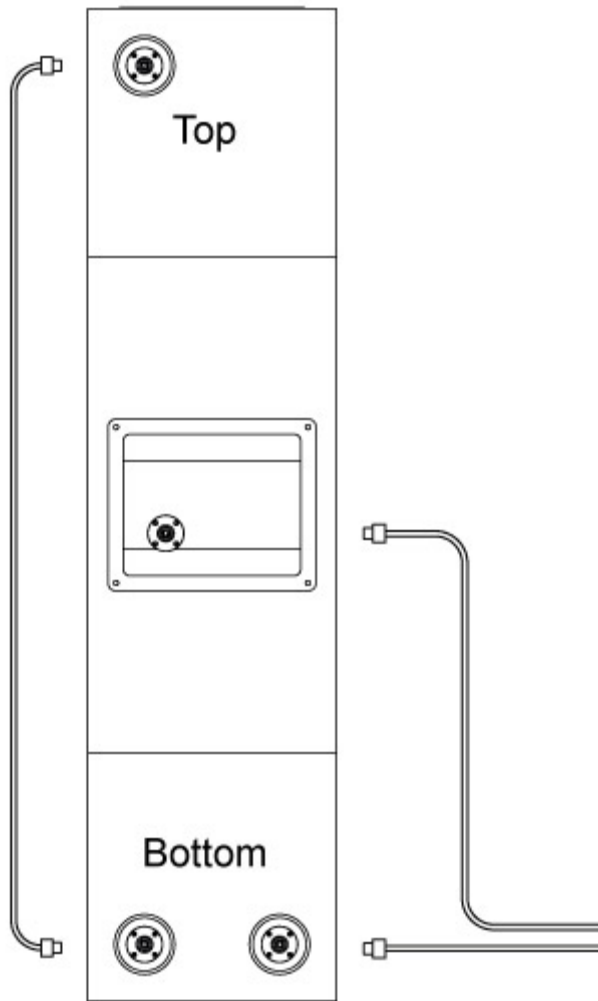

Mounting the top and bottom brackets

Secure the dedicated top and bottom brackets to the loudspeakers as shown.

- Attach the top bracket with M 6 x 12 screws.
Two (2) screws per speaker.

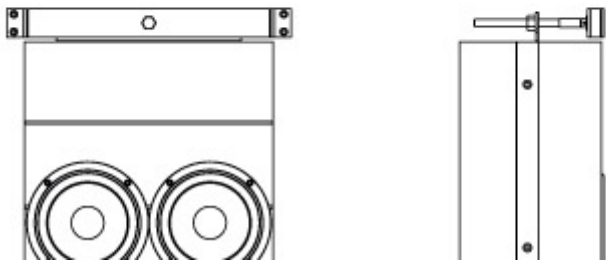
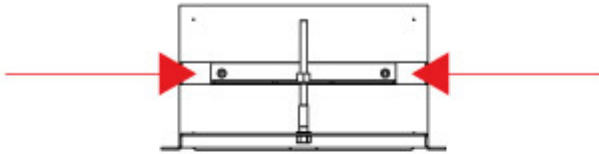

- Attach bottom bracket with 5 x 20 wood screws.
Four (4) screws per speaker.

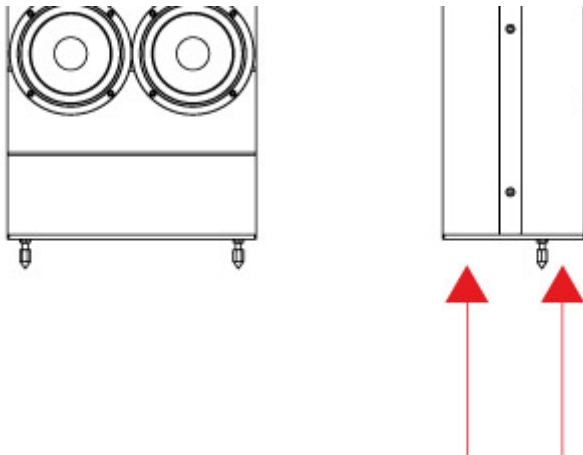

- Adjust the spikes to equal length.

Mounting the speaker in the wall

When all connections are complete and the relevant brackets are mounted, the speaker can be mounted in the wall cutout. Lift the speaker into the wall cutout and ensure the spikes attached to the bottom bracket are firmly placed on the floor.

Note: For your own safety, do not attempt to lift the speaker by yourself.

Mount the wall bracket at the top of the wall cutout as shown, fixing the bracket with 4 screws.

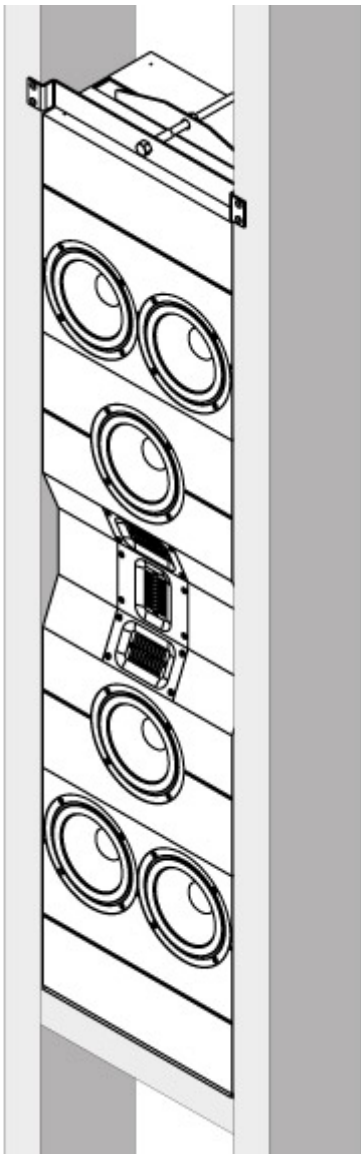

Note: The purpose of the top wall bracket is to stabilize the speaker and not to carry its weight.

S T E I N W A Y L Y N G D O R F

By adjusting the nut located in the center of the top bracket, it is possible to tilt the speaker back and forwards, which will give it optimal coverage of the primary listening position.

Service Information

In order to obtain warranty service, you must contact your original dealer or the Steinway Lyngdorf distributor of the region or country where you are located. If you have trouble locating an authorized representative, please contact the Steinway Lyngdorf Customer Service Department using the contact information at www.steinwaylyngdorf.com, or you may email service@steinwaylyngdorf.com.

Steinway Lyngdorf
Ulvevej 28
DK 7800 Skive
Denmark
Service Hotline: +45 4084 2230

In some cases, the Customer Service Department may solve a service problem without the need of repair or any other measures, thereby avoiding further inconvenience or delay. In some cases, it may be necessary to return the equipment to Steinway Lyngdorf or an authorized service provider for repair; therefore, it is recommended that you save your original packing materials. Steinway Lyngdorf will not be responsible for any damage due to unauthorized packing or shipment in non-original packing materials. If return is made in authorized packaging, risks are borne by Steinway Lyngdorf. Additional charges may occur if new packing materials are required for return shipment.